

## Ultra Short Throw LCD Projectors

Specifications		
Model name	CP-TW3506	CP-AW3506
Display system	3LCD	
Display device	Size of effective display area	0.59", aspect ratio 16 : 10
	Number of pixels	1,024,000 pixels (1280 horizontal x 800 vertical)
Lens	Zoom	Digital zoom (1.35x)
	Focus	Powered
Light source	250W (high pressure mercury lamp)	
Screen size	60 - 100 inch	
Light output (Brightness)	3,700 lm <sup>1</sup>	
Contrast ratio (full white / full black)	20,000 : 1 <sup>2</sup>	
Speaker	16W x 1 mono	
Displayable scanning frequency	Horizontal	15 - 106 kHz
	Vertical	50 - 120 Hz
Display resolution	Computer	VGA, SVGA, XGA, WXGA, SXGA, WXGA+, WXGA++, WSXGA+, UXGA, Full HD, Mac 16"
	Video	NTSC, NTSC4.43, PAL, SECAM, PAL-M, PAL-N, PAL(60Hz), 480i@60, 480p@60, 576i@50, 576p@50, 720p@50/60, 1080i@50/60, 1080p@50/60
Terminals	COMPUTER IN 1	Mini-D-sub 15-pin connector x 1
	COMPUTER IN 2 / MONITOR OUT	Mini-D-sub 15-pin connector x 1
	VIDEO	Composite video (RCA connector) x 1
	HDMI IN	HDMI connector x 2 (HDCP compliant)
	MHL IN	HDMI connector x 1 (HDCP compliant)
	Shared with HDMI1 input terminal	
	AUDIO IN	3.5mm stereo mini connector x 1, RCA connector L/R x 1
	AUDIO OUT	3.5mm stereo mini connector x 1
	Microphone Input	3.5mm mono mini connector x 1
	CONTROL(RS-232C)	D-sub 9-pin connector x 1
LAN	RJ45 connector x 1	
USB-A	USB type A x 2 (PC less Presentation or wireless adapter)	
USB-B	USB type B x 1 (Interactive Function, USB mouse control and USB Display) USB type B x 1 (USB Display and USB mouse control)	
Operating temperature	0 - 40°C (When the ambient temperature exceeds 35°C, the brightness of the lamp is reduced automatically.)	
Operating humidity (RH)	20 - 80%RH (non-condensing)	
Power requirements	AC 100-120V(50/60Hz) : 3.8A , AC 220-240V(50/60Hz) : 1.9A	
Power consumption	AC 100-120V:380W , AC 220-240V:360W	
Standby mode power consumption	0.35W at saving mode <sup>3</sup>	
Standard outside dimensions (W x H x D)	382mm x 141mm x 362mm (15.0" x 5.6" x 14.3")	
	377mm x 136mm x 360mm (14.8" x 5.4" x 14.2") (Excluding protrusions)	
Weight	Approx. 4.5kg (9.9 lbs.) Approx. 4.3kg (9.5 lbs.)	
Accessories	Remote control, AA batteries, Power cord, Computer cable, Cable cover, Adapter cover, User's manuals, Security label, Application CD, USB cable, Interactive Pen, AAA batteries, Pen tips, Application DVD	Remote control, AA batteries, Power cord, Computer cable, Cable cover, Adapter cover, User's manuals, Security label, Application CD
Optional parts	Lamp	DT01411
	Filter set	UX37191
	Mounting accessories	HAS-AW100 (Bracket for ceiling mount), HAS-203L (Fixing adapter for low ceilings), HAS-P100 (Fixing adapter for high ceilings), HAS-WM03 (Wall mount unit), HAS-WM05 (Wall mount unit)
	Tabletop use kit	TT-03
	USB wireless adapter	USB-WL-11N
	Interactive Pen	I-PEN4
Finger Touch Unit	FT-01B	-

<sup>1</sup> When PICTURE MODE is set to DYNAMIC, and ACTIVE IRIS is set to OFF. <sup>2</sup> When PICTURE MODE is set to DYNAMIC, and ACTIVE IRIS is set to PRESENTATION. <sup>3</sup> SAVING mode disables the functions of MONITOR OUT, AUDIO OUT, speaker sound, network communication, RS-232C control except POWER ON command, etc. in standby.

Environment	
<ul style="list-style-type: none"> <li>▶ <b>Compliance with EU Directive RoHS<sup>1</sup></b></li> <li>▶ <b>Reduction of resin usage in production</b> Use of hot runners in molds for making upper housing in order to reduce mill ends.</li> <li>▶ <b>Power saving mode engaged during standby</b></li> <li>▶ <b>Eco mode</b> Eco mode provides power saving.</li> </ul>	<p><sup>1</sup> RoHS is the acronym of "Directive 2011/65/EU of the European Parliament and of the Council of 8 June 2011 on the restriction of the use of certain hazardous substances in electrical and electronic equipment".</p>

### Dimensions

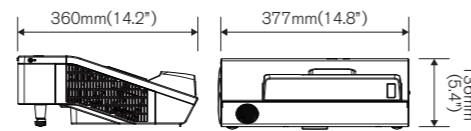

### Projection Distance

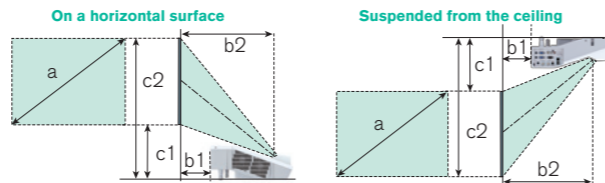

The figures above are not drawn to scale.

CP-TW3506, CP-AW3506		(1,280 x 800) (±8%)							
Screen size(diagonal) type (inch)	Projection distance				Screen height				
	a	b1	b2	c1	c2	m	inch	m	inch
60	1.5	0.128	5.0	0.409	16.1	0.313	12.3	1.121	44.1
65	1.7	0.163	6.4	0.444	17.5	0.332	13.1	1,207	47.5
70	1.8	0.198	7.8	0.479	18.9	0.351	13.8	1,293	50.9
75	1.9	0.233	9.2	0.514	20.2	0.369	14.5	1,379	54.3
80	2.0	0.268	10.5	0.549	21.6	0.388	15.3	1,465	57.7
85	2.2	0.303	11.9	0.584	23.0	0.407	16.0	1,551	61.1
90	2.3	0.338	13.3	0.619	24.4	0.426	16.8	1,638	64.5
95	2.4	0.373	14.7	0.654	25.7	0.445	17.5	1,724	67.9
100	2.5	0.408	16.1	0.689	27.1	0.464	18.3	1,810	71.3

### Terminals

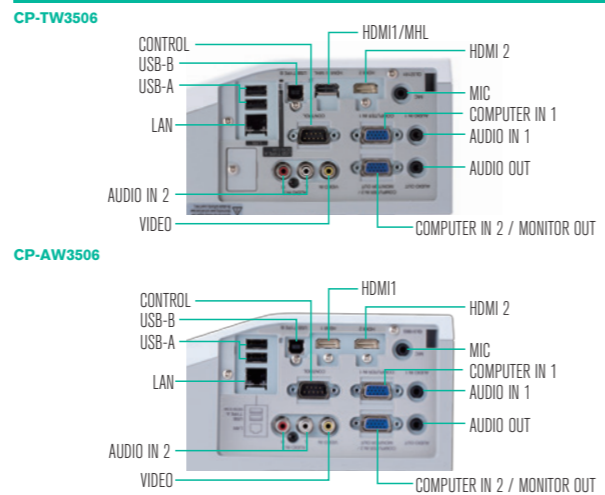

# Ultra short throw projectors that provide vivid images in bright classrooms and meeting rooms

\*Projected images are simulations

## HITACHI

Hitachi America, Ltd., Digital Media Division 2420 Fenton Street, Suite 200 Chula Vista, CA 91914, U.S.A. and Canada Tel: +1-800-448-2224 www.hitachi-america.us/digitalmedia  
 Hitachi Home Electronics Asia (S) Pte. Ltd. 438A Alexandra Road #01-01/02/03, Alexandra Technopark, 119967, Singapore Tel: +65-6536-2520 www.hitachiconsumer.com.sg  
 Hitachi Sales (Malaysia) Sdn. Bhd. Lot 12, Jalan Kemajuan, Bangi Industrial Estate, 43650 Bandar Baru Bangi, Selangor Darul Ehsan, Malaysia Tel: +60-3-8911-2670 www.hitachiconsumer.com.my  
 Hitachi Sales (Thailand), Ltd. 333, 333/1-8 Moo 13, Bangna-Trad Road km 7, Bangkaew, Bangplee, Samutprakarn 10540, Thailand Tel: +66-2335-5455 www.hitachi-th.com  
 Hitachi (Hong Kong), Ltd. 18th Floor, Ever Gain Centre, 28 On Muk Street, Shatin, N.T., Hong Kong Tel: +852-2113-8883 www.hitachi-hk.com.hk  
 Hitachi Sales Corp. of Taiwan 2nd Floor, No.65, Nanking East Road, Section 3, Taipei 104, Taiwan Tel: +886-2-2516-0500 www.hsct.com.tw  
 Hitachi Australia Pty Ltd. Suite 801, Level 8, 123 Epping Road, North Ryde NSW 2113, Australia Tel: +61-2-9888-4100 www.hitachi.com.au  
 Hitachi Europe Ltd., Digital Media Group Consumer Affairs Department Whitebrook Park, Lower Cookham Road, Maidenhead, Berkshire, SL6 8YA, UK Tel: +44-844-481-0297 www.hitachidigitalmedia.com  
 Hitachi Consumer Marketing, Inc. http://www.hitachi.co.jp/proj/

October 2017

NM-E500 102017



Ultra short throw interactive projector CP-TW3506

Ultra short throw projector CP-AW3506

## Project visual beauty in real time. Technology that delivers details in bright environments.

The video processing technology enhances high-definition video in real time. Using this technology, you can enjoy high-definition images without losing the color information of the original image, and project high-definition video in classrooms, lecture halls, large meeting rooms, and other bright spaces.



### LINE UP \*Local availability may be limited.

#### Tseries Ultra Short Throw



**CP-TW3506**  
WXGA 3,700lm

#### Aseries Ultra Short Throw



**CP-AW3506**  
WXGA 3,700lm

### ACCENTUALIZER

This function makes pictures look more real by enhancing (1) Shade, (2) Sharpness and (3) Gloss to make pictures clear. You can also adjust the effects by three levels according to your surroundings, video contents, etc.

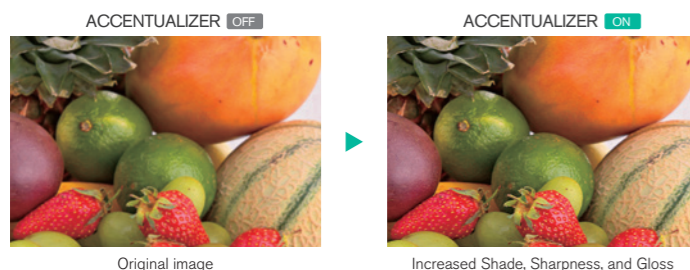

### Image Optimizer

Equipped with IMAGE OPTIMIZER that maintains visibility of an image through automatic image correction in accordance with lamp consumption.

\* This function may not work properly when HDCR/ACCENTUALIZER is ON.

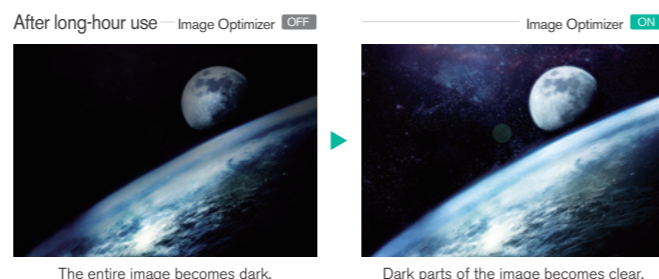

### HDCR (High Dynamic Contrast Range)

When average projectors are used in bright rooms, the darker colors of an image deteriorate and images become unclear. Using this function, blurred images caused by room lighting or outside light sources are corrected, and an effect similar to increasing contrast occurs. This results in clear images even in bright rooms.

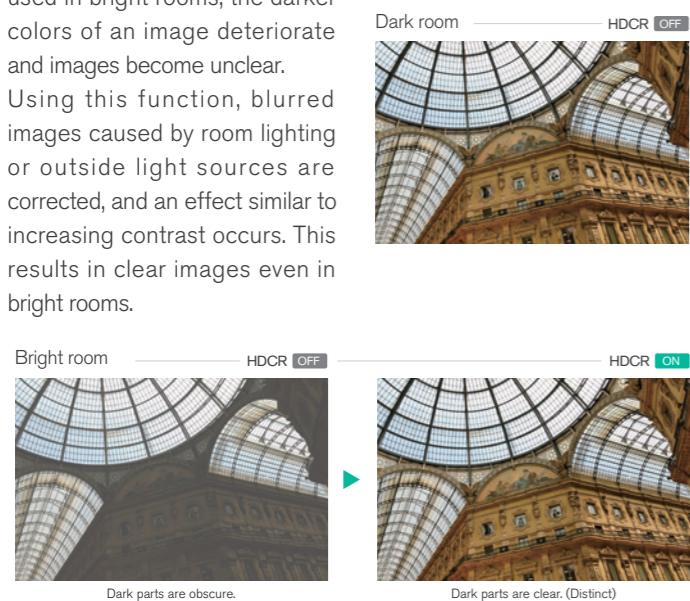

### DICOM® Simulation Mode

The DICOM (Digital Imaging and Communications in Medicine) Simulation Mode projects grayscale images which approximate DICOM Part 14 specifications. This mode is ideal for viewing grayscale medical images, such as X-rays, for training and educational purposes.

The projectors have a DICOM (Digital Imaging and Communications in Medicine) Simulation Mode. This mode simulates the DICOM standard, which is a standard applicable to digital communications in medicine, and is useful for displaying medical images such as X-rays. These projectors are not medical devices and are not compliant with the DICOM standard, and neither the projector nor the DICOM Simulation Mode should be used for medical diagnosis.  
\* Comparison photos are simulations.

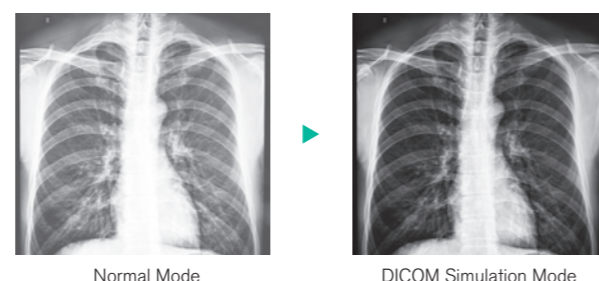

\* The above images are representations of the effects and differ from actual images.

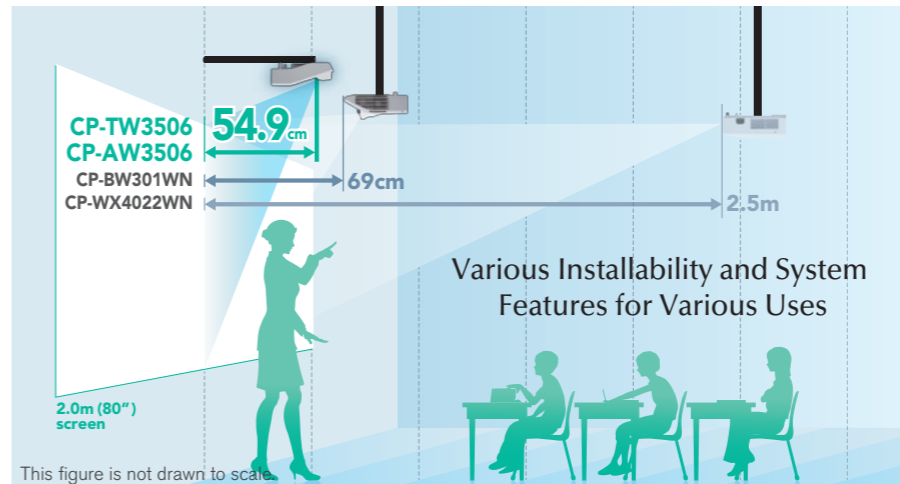

### Reduced Glare and Shadows

These projectors feature Ultra Short Throw, for projecting a 2m (80inches) image from only 54.9cm (21.6inches) onto a wall or screen. Ultra Short Throw greatly reduces glare from the projector's light source, making it easier for the teacher or presenter to see the audience. The audience also has a clearer view because the shadows of the teacher's or presenter's hands and body are minimized. The result is a better classroom or meeting room experience for everyone.

### Powered Focus and Perfect Fit

Equipped with powered focus and Perfect Fit with which the position of four corners and four sides of a projected image can be adjusted. With the remote controller at hand, you can adjust focus and the position of an image.

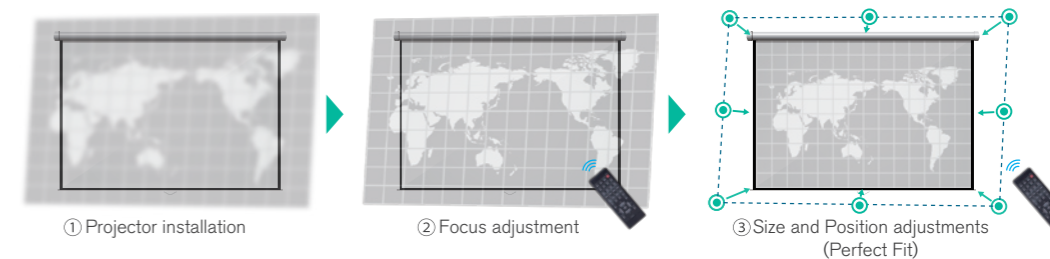

### 2 - HDMI & MHL\*1 inputs

Equipped with 2 HDMI input terminals for the current widely-used interface.

\* HDMI cable is not included in the box.

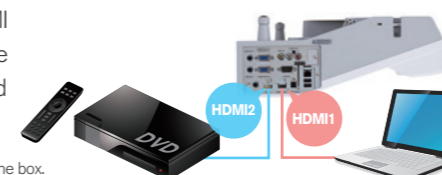

Project images by connecting a smartphone or tablet that supports MHL to the projector using an MHL cable.

\*1 For T series projector only. MHL cable is not included in the box.



### Tabletop Use (Option)



The optional tabletop use kit TT-03 allows to stand the projector vertically and a 1.5m (60") diagonal image down onto a table.

### 16W Internal Speaker

Equipped with a 16W speaker and microphone terminal that allow you to comfortably make presentations using content with sound or using a microphone.

## Various Network Features

### Wireless Capability (Option)

Connect a projector to a computer using the optional USB wireless adapter. The adapter supports IEEE 802.11b/g/n.

#### SIMPLE ACCESS POINT mode



Without an access point

#### INFRASTRUCTURE mode



With an access point

### Easy WLAN Connection

Searches available wireless networks and displays the list of SSIDs when used in Infrastructure mode. You can select an SSID to connect to from the list.

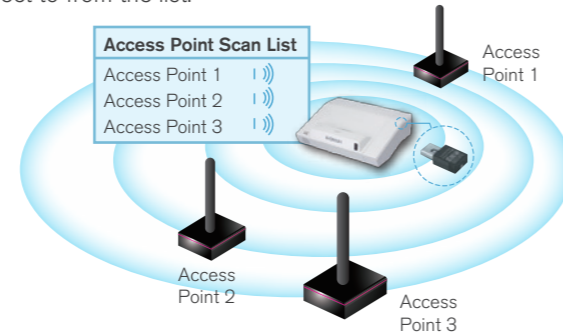

### Convenient Networking

Manage and control multiple projectors over your LAN with Centralized Reporting, Scheduling, E-mail Alerts, and My Image (Image Transfer).

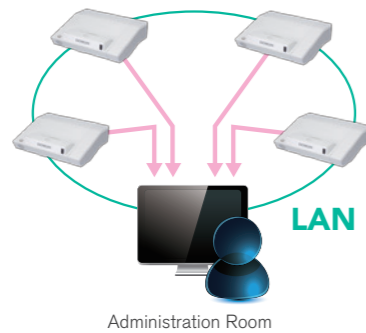

### Multi Projector

You can project the same image to up to 12 projectors simultaneously. This is useful for meetings and lectures in large venues where a single screen would not be sufficient.

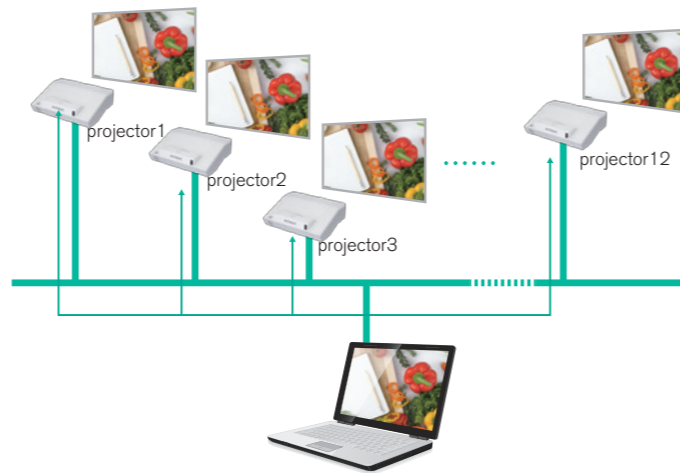

### Easy Schedule Setting

You can schedule routine and special projector events, including power on, power off, input selection and other settings.

EVENT SCHEDULE			
MONDAY to FRIDAY			
08:00	POWER	ON	
	INPUTSOURCE	COMPUTER IN 1	
12:30	INPUTSOURCE	HDMI 1	
17:00	POWER	OFF	

### Smart Device Control

Plugging the optional USB wireless adapter to the projector and using the dedicated free online application developed by Hitachi, projectors can be controlled from a tablet or smartphone.



\* See the Hitachi website for details [http://www.hitachi.co.jp/proj/en/apps/pj\\_connection.html](http://www.hitachi.co.jp/proj/en/apps/pj_connection.html)

### Moderator Control Mode

Setting one computer from the multiple computers (up to 50) that are connected to the projector as the moderator (host) makes it possible for the moderator to project from the other computers (Clients).

\* Moderator Control Mode supports LiveViewer 6 (Windows® application) only.

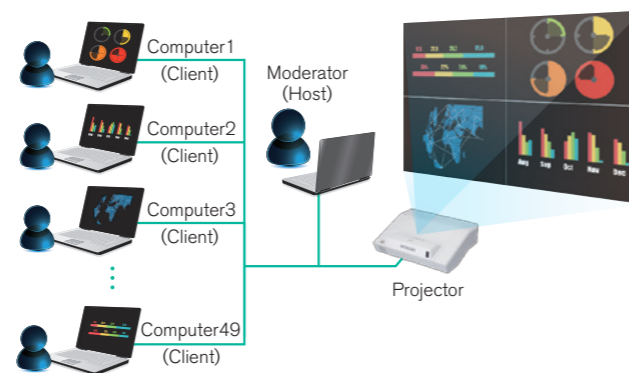

## Go Green

### Saver Mode



This feature developed by Hitachi reduces the projector lamp brightness and consumption power, resulting in considerable energy savings. Set the Saver mode time from 1 to 30 minutes, and if the projected image does not change in that time, Saver mode activates. Saver mode can also be activated manually.



During a presentation using the screen.

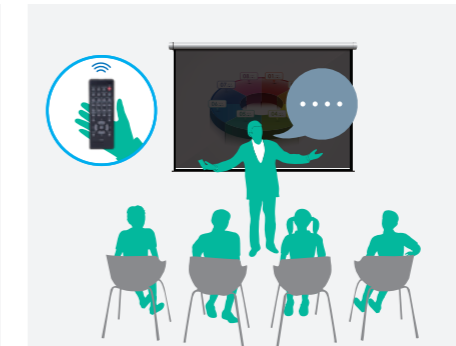

Darken the screen with the remote control while the presenter speaks.



The screen automatically turns dark when not in use during group discussions.

### Intelligent Eco Mode

This feature developed by Hitachi automatically changes the brightness of the lamp according to the level of the input signal. Lamp brightness is reduced when a darker image is projected, and returns to normal when a brighter image is projected, eliminating unnecessary energy consumption from the lamp.

### Eco Mode

Using Eco Mode reduces lamp power approximately 32% compared to 250W in Normal Mode.

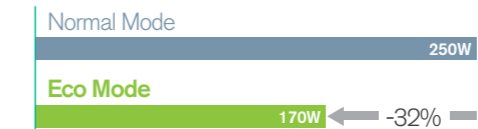

\* Lamp brightness in Eco Mode is lower compared to Normal Mode.

### Saving Mode

Consumption power can be reduced to 0.35W when in standby, making it possible to reduce running costs.

\* STANDBY MODE must be set to SAVING.  
\* Available functions during standby when SAVING is set are limited.

## High Reliability and Stability

### Easy Maintenance

The lamp door and the filter cover are located on the top and the side, facilitating maintenance and replacement even when the projector is installed on the ceiling.



### Hybrid Filter

The hybrid filter is composed of an unwoven cloth and a HAF (High Air Flow) filter, protecting the optics from dust, dirt, and chalk particles. The filter can last up to 4,000 hours\*1 without cleaning.

\*1 Varies according to usage environment.



### 3LCD chips with Inorganic Alignment Layers

These Hitachi 3LCD projectors incorporate three LCD panels with inorganic alignment layers that are extremely light resistant, increasing brightness and contrast ratio. They provide smooth images and high reliability.

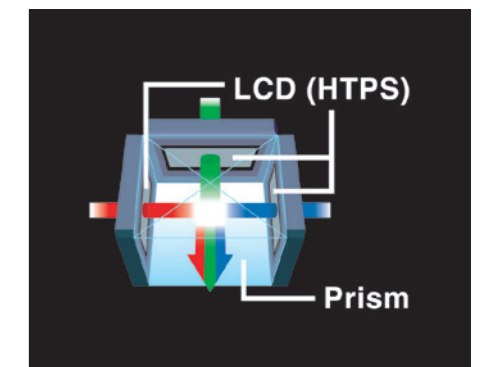

## An interactive function with enhanced operability and functionality



### Advanced Writing/Drawing Capabilities

#### PC less Drawing

T Series projector comes with a built-in drawing function allowing you to directly draw and write on the projected screen without a PC.

#### Directly Draw on the Projected Screen

You can write and draw on images projected from connected devices such as Document camera.

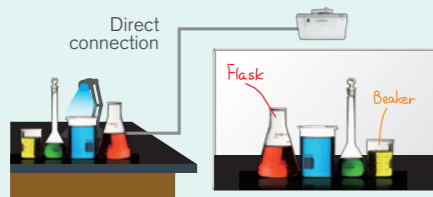

#### Save and Open Drawn Screens

You can save the image drawn on the projector screen. This enables you to easily manage what you've taught in the past.

#### Convenient Painter Tool

Equipped with the Pen, Eraser, Undo, Redo functions. You can also change the pen color and thickness. With the easy-to-use Painter tool bar, you can teach classes smoothly.



#### Variety Rich Templates

You can conveniently use the interactive function with over 100 pre-installed templates including graphs, Graphic Organizers, Plain Color, and many more.



#### Finger Touch (Option)

The T Series projector incorporates the optional finger touch unit that enables the projector to detect finger touch activity on the screen area. It allows users to annotate and interact with the material presented. Instead of simply showing static images, students and teachers can interact with on screen material for hands-on interactivity that brings learning to life.

\* When using the finger touch unit at bright environment, auto calibration may not be used.  
 \* Please use the finger touch unit on a flat screen.  
 \* The finger touch unit may not be used in locations where there is sunlight or light from an incandescent light source.

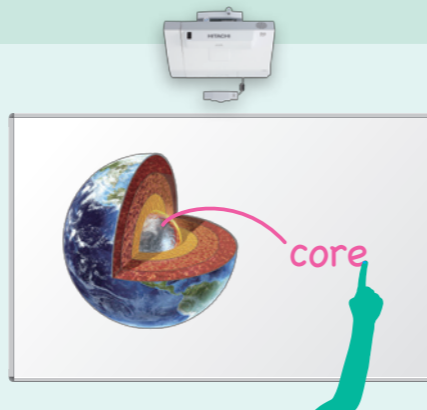

#### Multiple interactive pens

With up to 6 interactive pens pupils can do more than just watch - they can interact with the onscreen content. Let them enjoy providing answers, showing their understanding and becoming involved in lessons as never before.



#### Windows® multi touch

Windows® 8.1 / 10 multi touch allows users with touch enabled Windows® 8.1 / 10 systems to operate the PC directly from the interactive screen with up to 6 of pens or touches\* including Windows® 8.1 / 10 gesture.

\* Optional finger touch unit is required.

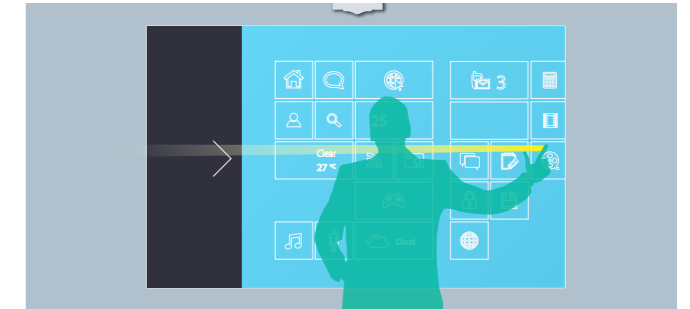

#### Auto Calibration

Auto calibration is completed easily and quickly with the remote control. Calibration can be performed and the interactive function can be used on both the 16 : 10 and 4 : 3 screen type.

\* The image for aligning the position is displayed automatically.

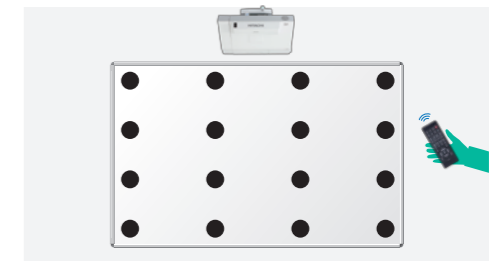

### Interactive Software

This product includes a drawing application that offers more sophisticated drawing functions.

#### Neatly Convert Letters or Figures

You can automatically convert freehand shapes into geometric objects and handwriting into text on the projected image. These operations are easily accomplished with the interactive pen.



#### Select a Variety of Useful Tools

The interactive pen lets you operate a compass, ruler, protractor, stopwatch and other useful tools on the projected image, making lessons even easier to understand.

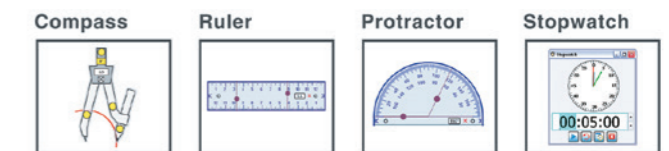

#### System requirements for drawing application

- **Windows®**
  - **CPU:** Intel® Pentium® 4 (1.8GHz or faster) • **HDD:** 900 MB free space • **Memory:** 1 GB or more • **Display:** 32bit • **OS:** Windows® 7 (32/64bit), Windows® 8.1 (32/64bit), Windows® 10 (32/64bit) (The drawing application has been verified with the latest service pack at the time of release. The drawing application does not support Windows® Tablet PC Edition and Server Edition.) • **Network:** Internet-connected environment • **Application:** Internet Explorer® 9 / 10 / 11, Microsoft® Word 2010/2013, Microsoft® Excel® 2010/2013, Microsoft® PowerPoint® 2010/2013, Adobe® Reader® X/XI, Adobe® Acrobat® Reader® DC, Adobe® Flash® Player 11 • **Others:** DVD-ROM drive, Video cards supporting hardware overlay feature (for using the movie features) [When using the Webcam function] DV (digital video devices, DV camera, D-VHS etc.), Capture Devices which support DirectShow with WDM drivers [For hosting a remote conference] • **CPU:** Intel® Core™2 Duo 2.0GHz or faster • **HDD:** 2GB or more free space • **Memory:** 2GB or more • **Others:** TCP/IP Network of 54Mbps or greater [For i-Learn: maths toolbox] • **Display:** 1024x768 or higher • **Application:** Adobe® Reader® • **Others:** 32bit color 3D graphic card
- **Macintosh**
  - **CPU:** Intel® CPU • **HDD:** 900 MB free space • **Memory:** 1GB or more • **Display:** High Color (16bit) or more • **OS:** Mac OS X 10.9/10.10/10.11 • **Network:** Internet-connected environment • **Application:** Adobe® Flash® Player 11 • **Others:** DVD-ROM drive [For hosting a remote conference] • **CPU:** Intel® Core™2 Duo 2.0GHz or faster • **HDD:** 2GB or more free space • **Memory:** 2GB or more • **Others:** TCP/IP Network of 54Mbps or greater [For i-Learn: maths toolbox] • **Display:** 1024 x 768 or higher • **Application:** Adobe® Reader® • **Others:** 32bit color 3D graphic card